

IS 10322



R-41163970



ARCHITECTURAL LIGHTING
GENERAL LIGHTING

2022

PRODUCT CATALOGUE

CHENGDU MQ ELEC-OPTIC TECH CO.,LTD

NO.3 Floor 14,Building 2, No.368 Tianfu 2rd Road,
Gaoxin District, Chengdu,Sichuan,China

Mob:0086 18180547735

www.mqledlighting.com

INDIAN OFFICE:GSN SYSTEMS & AUTOMATION

NO. 3058/4, 8 th A Cross,14 th Main Road, Vijayanagar,
2 nd Stage,BANGALURU - INDIA;ZIP CODE : 560040

Attn:G.RAMESH

Mob:0091 09845626899 /9341458885



index

牛魔王系列
Cow Devil Baking Series
PAGE 001-012

悟空系列
Wukong series
PAGE 013-026

线条灯系列
Linear Light Series
PAGE 027-054

迷你射灯系列
Mini Spotlight Series
PAGE 055-058

酒店射灯系列
Spot Light Series
PAGE 059-070

面板灯系列
Panel light series
PAGE 071-080

筒射灯系列
Down Light Series
PAGE 081-099

轨道灯系列
Track Light Series
PAGE 100

NEW

NMW-HGD

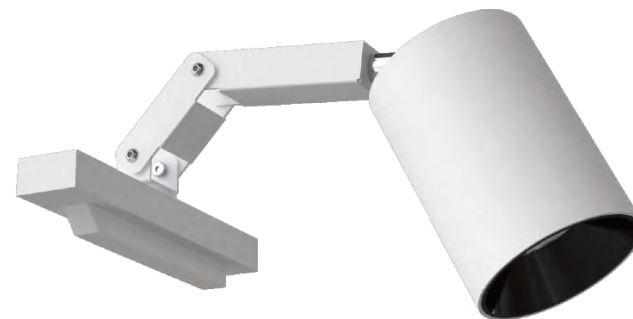

NMW-HGD-54

Power: 10W
Lumen: 900lm

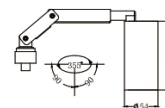

NMW-HGD-68

Power: 20W
Lumen: 1800lm

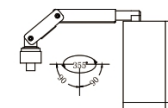

NMW-HGD-85

Power: 30W
Lumen: 2700lm

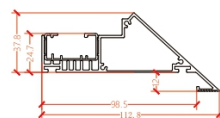
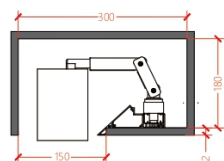
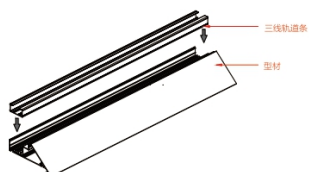
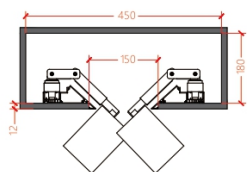
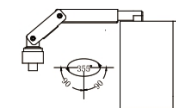

/Beam

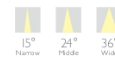

/Chip



/Available Colors



NEW

NMW-GD



NMW-GD-54

功率 [Power]: 10W
流明 [Lumen]: 900lm

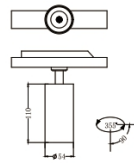

光学角度/Beam



芯片/Chip



可选反射器颜色/Available Colors



NMW-GD-68

功率 [Power]: 20W
流明 [Lumen]: 1800lm

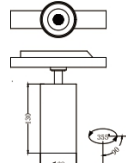

NMW-GD-85

功率 [Power]: 30W
流明 [Lumen]: 2700lm

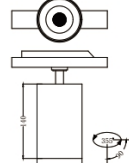

NEW

NMW-WX



NMW-WX-100

功率 [Power]: 10W
流明 [Lumen]: 1800lm

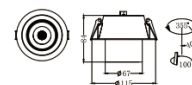

光学角度/Beam



芯片/Chip



NMW-WX-170

功率 [Power]: 30W
流明 [Lumen]: 2700lm

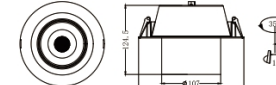

可选反射器颜色/Available Colors





NMW-TD-50

功率 [Power]: 5W
流明 [Lumen]: 450lm

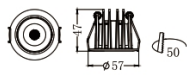

NMW-TD-60

功率 [Power]: 9W
流明 [Lumen]: 810lm

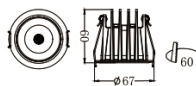

NMW-TD-75

功率 [Power]: 12W
流明 [Lumen]: 1080lm

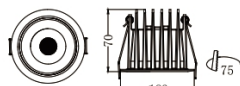

NMW-TD-90

功率 [Power]: 20W
流明 [Lumen]: 1800lm

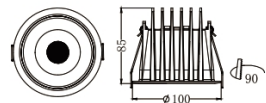

NMW-TD-120

功率 [Power]: 30W
流明 [Lumen]: 2700lm

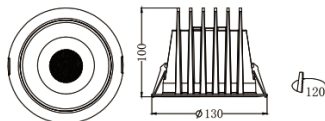

光学角度/Beam



芯片/Chip



可选反射器颜色/Available Colors



NMW-TSD-60

功率 [Power]: 7W
流明 [Lumen]: 630lm

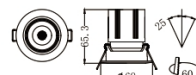

NMW-TSD-75

功率 [Power]: 12W
流明 [Lumen]: 1080lm

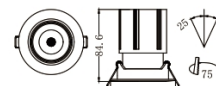

NMW-TSD-90

功率 [Power]: 20W
流明 [Lumen]: 1800lm



NMW-TSD-110

功率 [Power]: 30W
流明 [Lumen]: 2700lm

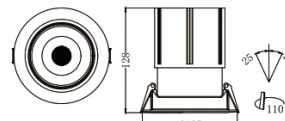

光学角度/Beam



芯片/Chip



可选反射器颜色/Available Colors





NMW-GSD-R75

功率 [Power]: 7W
流明 [Lumen]: 630lm

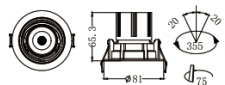

NMW-GSD-R90

功率 [Power]: 12W
流明 [Lumen]: 1080lm

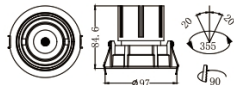

NMW-GSD-R105

功率 [Power]: 20W
流明 [Lumen]: 1800lm

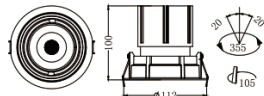

NMW-GSD-R120

功率 [Power]: 30W
流明 [Lumen]: 2700lm

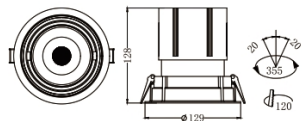

光学角度/Beam



芯片/Chip



可选反射器颜色/Available Colors



NMW-GSD-S75

功率 [Power]: 7W
流明 [Lumen]: 630lm

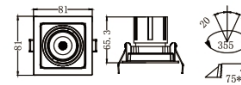

NMW-GSD-S90

功率 [Power]: 12W
流明 [Lumen]: 1080lm

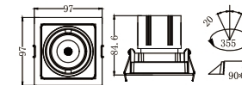

NMW-GSD-S105

功率 [Power]: 20W
流明 [Lumen]: 1800lm

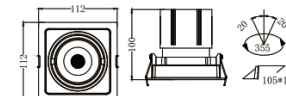

NMW-GSD-S120

功率 [Power]: 30W
流明 [Lumen]: 2700lm

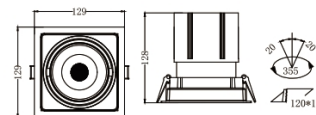

光学角度/Beam



芯片/Chip



可选反射器颜色/Available Colors



NEW

NMW-GSD



NMW-GSD-S75-2

功率 [Power]: 2*7W
流明 [Lumen]: 1260lm

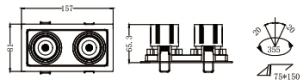

NMW-GSD-S90-2

功率 [Power]: 2*12W
流明 [Lumen]: 2160lm

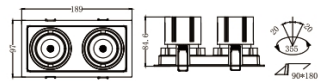

NMW-GSD-S105-2

功率 [Power]: 2*20W
流明 [Lumen]: 3600lm

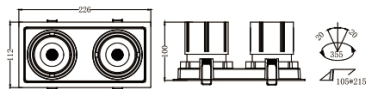

NMW-GSD-S120-2

功率 [Power]: 2*30W
流明 [Lumen]: 5400lm

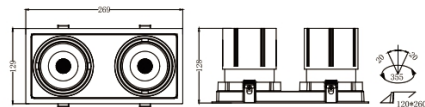

光学角度/Beam



15° Narrow 24° Midside 36° Wide

芯片/Chip



COB

可选反射器颜色/Available Colors



GB/黑色 W/白色

NEW

NMW-SD



NMW-R75

功率 [Power]: 12W
流明 [Lumen]: 960lm

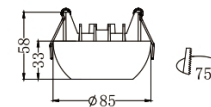

NMW-O75

功率 [Power]: 10W
流明 [Lumen]: 800lm

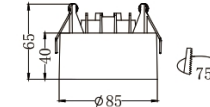

NMW-S75

功率 [Power]: 12W
流明 [Lumen]: 960lm

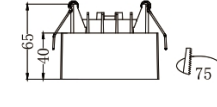
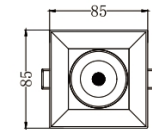

光学角度/Beam



15° Narrow 24° Midside 36° Wide

芯片/Chip



COB

可选反射器颜色/Available Colors



GB/黑色 W/白色



自由组合
多种造型
DIY你的空间

Combination Of
Magic
And Change



XTD-R



XTDR1-A-6



XTDR1-A-12



XTDR1-A-18



XTDR1-A-24



C-12



C-18



C-24



TD-12



TD-18



TD-24



SD-12



SD-18



SD-24



GD-12



GD-18



GD-24



XTDR1-B-06



XTDR1-B-12



XTDR1-B-18



XTDRI-A-06

功率 [Power]: 8W
 色温 [CCT]: 3000K | 4000K | 5000K
 流明 [Lumen]: 560lm
 眩光值 [UGR]: < 17
 显指 [CRI]: 90+
 材质 [Material]: Die casting aluminium
 颜色 [Color]: WH/BK

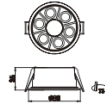

XTDRI-A-12

功率 [Power]: 15W
 色温 [CCT]: 3000K | 4000K | 5000K
 流明 [Lumen]: 1050lm
 眩光值 [UGR]: < 17
 显指 [CRI]: 90+
 材质 [Material]: Die casting aluminium
 颜色 [Color]: WH/BK

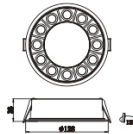

XTDRI-A-18

功率 [Power]: 20W
 色温 [CCT]: 3000K | 4000K | 5000K
 流明 [Lumen]: 1400lm
 眩光值 [UGR]: < 17
 显指 [CRI]: 90+
 材质 [Material]: Die casting aluminium
 颜色 [Color]: WH/BK

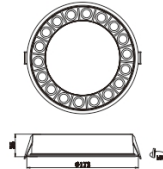

XTDRI-A-24

功率 [Power]: 30W
 色温 [CCT]: 3000K | 4000K | 5000K
 流明 [Lumen]: 2100lm
 眩光值 [UGR]: < 17
 显指 [CRI]: 90+
 材质 [Material]: Die casting aluminium
 颜色 [Color]: WH/BK

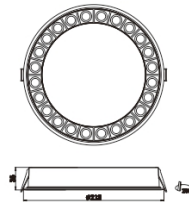

光学角度/Beam



芯片/Chip



可选反光器颜色/Available Colors



XTDRI-B-06

功率 [Power]: 8W
 色温 [CCT]: 3000K | 4000K | 5000K
 流明 [Lumen]: 560lm
 眩光值 [UGR]: < 17
 显指 [CRI]: 90+
 材质 [Material]: Die casting aluminium
 颜色 [Color]: WH/BK

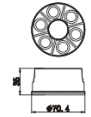

XTDRI-B-12

功率 [Power]: 15W
 色温 [CCT]: 3000K | 4000K | 5000K
 流明 [Lumen]: 1050lm
 眩光值 [UGR]: < 17
 显指 [CRI]: 90+
 材质 [Material]: Die casting aluminium
 颜色 [Color]: WH/BK

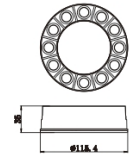

XTDRI-B-18

功率 [Power]: 20W
 色温 [CCT]: 3000K | 4000K | 5000K
 流明 [Lumen]: 1400lm
 眩光值 [UGR]: < 17
 显指 [CRI]: 90+
 材质 [Material]: Die casting aluminium
 颜色 [Color]: WH/BK

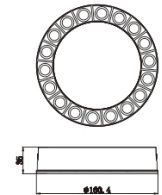

光学角度/Beam



芯片/Chip



可选反光器颜色/Available Colors



XTDR2-A-06

功率 [Power] : 8W
 色温 [CCT] : 3000K | 4000K | 5000K
 流明 [Lumen] : 560lm
 眩光值 [UGR] : < 17
 显指 [CRI] : 90+
 材质 [Material] : Die casting aluminium
 颜色 [Color] : WH/BK

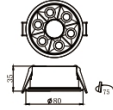

XTDR2-A-12

功率 [Power] : 15W
 色温 [CCT] : 3000K | 4000K | 5000K
 流明 [Lumen] : 1050lm
 眩光值 [UGR] : < 17
 显指 [CRI] : 90+
 材质 [Material] : Die casting aluminium
 颜色 [Color] : WH/BK

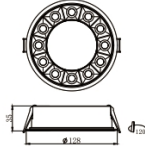

XTDR2-A-18

功率 [Power] : 20W
 色温 [CCT] : 3000K | 4000K | 5000K
 流明 [Lumen] : 1400lm
 眩光值 [UGR] : < 17
 显指 [CRI] : 90+
 材质 [Material] : Die casting aluminium
 颜色 [Color] : WH/BK

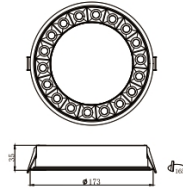

XTDR2-A-24

功率 [Power] : 30W
 色温 [CCT] : 3000K | 4000K | 5000K
 流明 [Lumen] : 2100lm
 眩光值 [UGR] : < 17
 显指 [CRI] : 90+
 材质 [Material] : Die casting aluminium
 颜色 [Color] : WH/BK

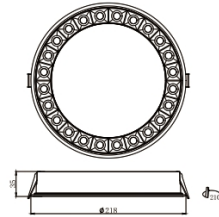

光学角度/Beam



芯片/Chip



可选反光器颜色/Available Colors



XTDR2-B-06

功率 [Power] : 8W
 色温 [CCT] : 3000K | 4000K | 5000K
 流明 [Lumen] : 560lm
 眩光值 [UGR] : < 17
 显指 [CRI] : 90+
 材质 [Material] : Die casting aluminium
 颜色 [Color] : WH/BK

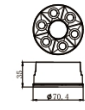

XTDR2-B-12

功率 [Power] : 15W
 色温 [CCT] : 3000K | 4000K | 5000K
 流明 [Lumen] : 1050lm
 眩光值 [UGR] : < 17
 显指 [CRI] : 90+
 材质 [Material] : Die casting aluminium
 颜色 [Color] : WH/BK

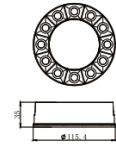

XTDR2-B-18

功率 [Power] : 20W
 色温 [CCT] : 3000K | 4000K | 5000K
 流明 [Lumen] : 1400lm
 眩光值 [UGR] : < 17
 显指 [CRI] : 90+
 材质 [Material] : Die casting aluminium
 颜色 [Color] : WH/BK

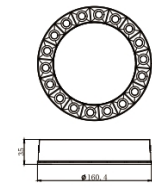

光学角度/Beam



芯片/Chip



可选反光器颜色/Available Colors



**GD-12**

功率 [Power] : 3W
 色温 [CCT] : 3000K | 4000K | 5000K
 流明 [Lumen] : 200lm
 眩光值 [UGR] : < 17
 显指 [CRI] : 90+
 材质 [Material] : Die casting aluminium
 颜色 [Color] : WH/BK

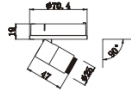
**GD-18**

功率 [Power] : 8W
 色温 [CCT] : 3000K | 4000K | 5000K
 流明 [Lumen] : 480lm
 眩光值 [UGR] : < 17
 显指 [CRI] : 90+
 材质 [Material] : Die casting aluminium
 颜色 [Color] : WH/BK

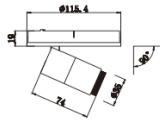
**GD-24**

功率 [Power] : 12W
 色温 [CCT] : 3000K | 4000K | 5000K
 流明 [Lumen] : 900lm
 眩光值 [UGR] : < 17
 显指 [CRI] : 90+
 材质 [Material] : Die casting aluminium
 颜色 [Color] : WH/BK

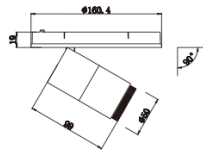

光学角度/Beam



20° ~ 50°

芯片/Chip



SMD

可选反光器颜色/Available Colors

Matte Black

**TD-12**

功率 [Power] : 7W
 色温 [CCT] : 3000K | 4000K | 5000K
 流明 [Lumen] : 500lm
 眩光值 [UGR] : UGR: < 17
 显指 [CRI] : 90+
 材质 [Material] : Die casting aluminium
 颜色 [Color] : WH/BK

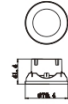
**TD-18**

功率 [Power] : 10W
 色温 [CCT] : 3000K | 4000K | 5000K
 流明 [Lumen] : 800lm
 眩光值 [UGR] : < 17
 显指 [CRI] : 90+
 材质 [Material] : Die casting aluminium
 颜色 [Color] : WH/BK

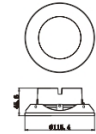
**TD-24**

功率 [Power] : 15W
 色温 [CCT] : 3000K | 4000K | 5000K
 流明 [Lumen] : 1200lm
 眩光值 [UGR] : < 17
 显指 [CRI] : 90+
 材质 [Material] : Die casting aluminium
 颜色 [Color] : WH/BK

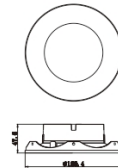

光学角度/Beam



120°

芯片/Chip



SMD

可选反光器颜色/Available Colors

White

**SD-12**

功率 [Power] : 7W
 色温 [CCT] : 3000K | 4000K | 5000K | 6000K
 流明 [Lumen] : 420lm
 遮光角 [Shielding angle] : 31.8°
 眩光值 [UGR] : <17
 显指 [CRI] : 90+
 材质 [Material] : Die casting aluminium
 颜色 [Color] : WH/BK

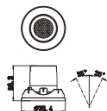
**SD-18**

功率 [Power] : 12W
 色温 [CCT] : 3000K | 4000K | 5000K | 6000K
 流明 [Lumen] : 720lm
 遮光角 [Shielding angle] : 31.8°
 眩光值 [UGR] : <17
 显指 [CRI] : 90+
 材质 [Material] : Die casting aluminium
 颜色 [Color] : WH/BK

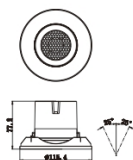
**SD-24**

功率 [Power] : 20W
 色温 [CCT] : 3000K | 4000K | 5000K | 6000K
 流明 [Lumen] : 1200lm
 遮光角 [Shielding angle] : 31.8°
 眩光值 [UGR] : <17
 显指 [CRI] : 90+
 材质 [Material] : Die casting aluminium
 颜色 [Color] : WH/BK

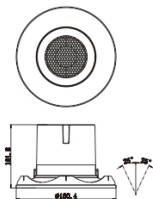

光学角度/Beam



12° 24° 36°

芯片/Chip



SMD

可选反光器颜色/Available Colors

White



MD009-12

功率 [Power] : 15W
 色温 [CCT] : 3000K | 4000K | 5000K
 流明 [Lumen] : 1050lm
 眩光值 [UGR] : < 17
 显指 [CRI] : 90+
 材质 [Material] : Die casting aluminium
 颜色 [Color] : WH/BK

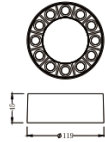

MD009-18

功率 [Power] : 20W
 色温 [CCT] : 3000K | 4000K | 5000K
 流明 [Lumen] : 1400lm
 眩光值 [UGR] : < 17
 显指 [CRI] : 90+
 材质 [Material] : Die casting aluminium
 颜色 [Color] : WH/BK

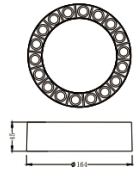

MD009-24

功率 [Power] : 30W
 色温 [CCT] : 3000K | 4000K | 5000K
 流明 [Lumen] : 2100lm
 眩光值 [UGR] : < 17
 显指 [CRI] : 90+
 材质 [Material] : Die casting aluminium
 颜色 [Color] : WH/BK

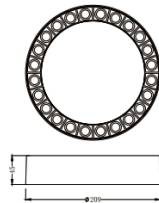

光学角度/Beam



芯片/Chip



可选反光器颜色/Available Colors



MD010-12

功率 [Power] : 15W
 色温 [CCT] : 3000K | 4000K | 5000K
 流明 [Lumen] : 1050lm
 眩光值 [UGR] : < 17
 显指 [CRI] : 90+
 材质 [Material] : Die casting aluminium
 颜色 [Color] : WH/BK

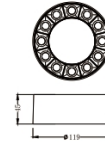

MD010-18

功率 [Power] : 20W
 色温 [CCT] : 3000K | 4000K | 5000K
 流明 [Lumen] : 1400lm
 眩光值 [UGR] : < 17
 显指 [CRI] : 90+
 材质 [Material] : Die casting aluminium
 颜色 [Color] : WH/BK

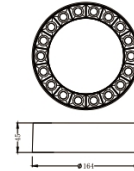

MD010-24

功率 [Power] : 30W
 色温 [CCT] : 3000K | 4000K | 5000K
 流明 [Lumen] : 2100lm
 眩光值 [UGR] : < 17
 显指 [CRI] : 90+
 材质 [Material] : Die casting aluminium
 颜色 [Color] : WH/BK

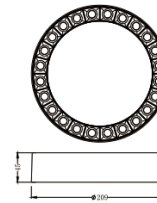

光学角度/Beam



芯片/Chip



可选反光器颜色/Available Colors





LINEAR

Light

线条灯系列

L I N E A R

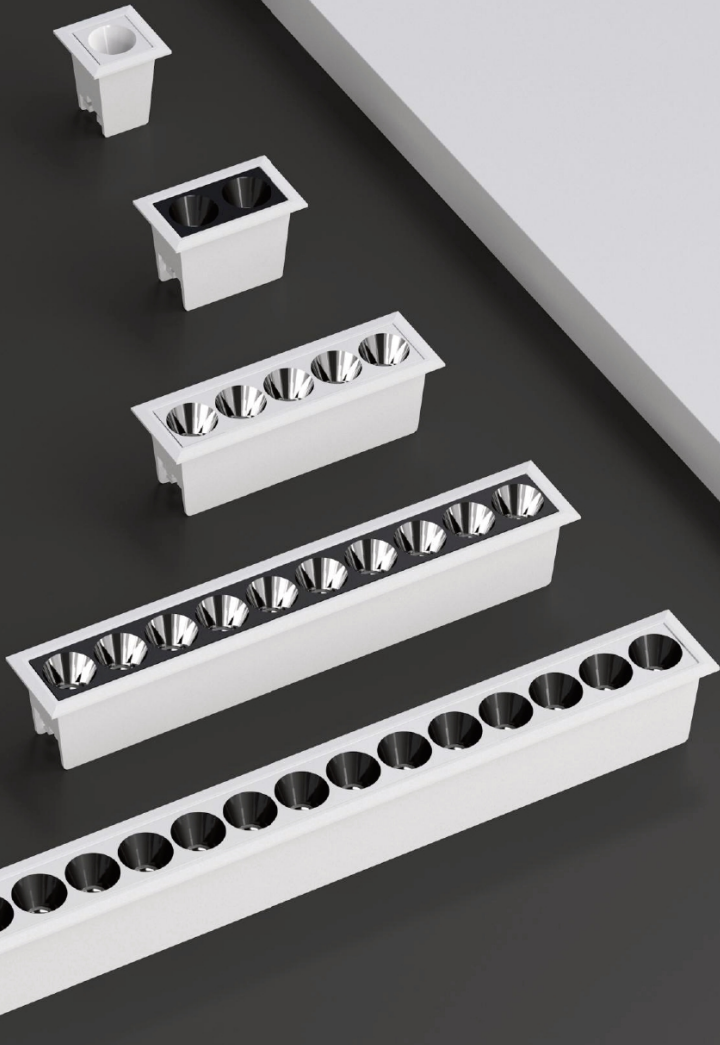

AW-XTD-AI



1 LED | 3W

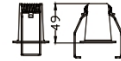

37*37
AW-XTD-AI-01



2 LED | 5W



68*37
AW-XTD-AI-02



5 LED | 12W

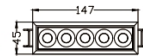

140*37
AW-XTD-AI-05

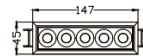

10 LED | 20W

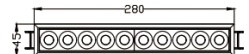

273*37
AW-XTD-AI-10

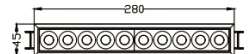

15 LED | 30W

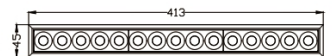

405*37
AW-XTD-AI-15

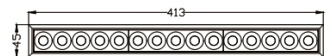

光学角度/Beam

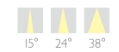

芯片/Chip



可选反射器颜色/Available Colors



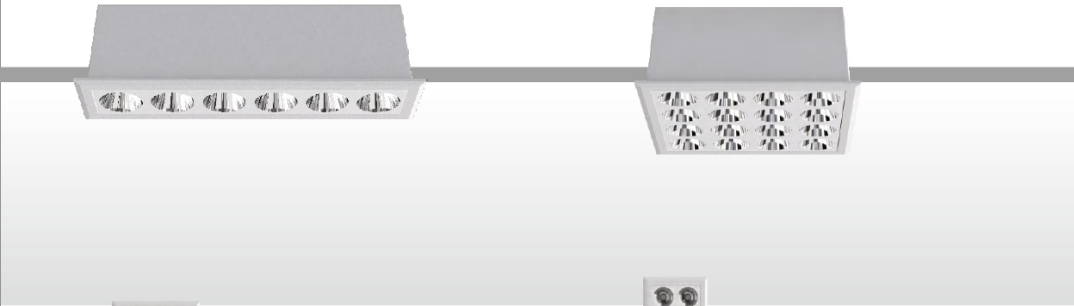

3 LED | 4W | 280lm
3000K | 4000K | 5000K | 6000K
UGR<17 | CRI 90+
Die casting aluminium



4 LED | 5W | 350lm
3000K | 4000K | 5000K | 6000K
UGR<17 | CRI 90+
Die casting aluminium



6 LED | 8W | 560lm
3000K | 4000K | 5000K | 6000K
UGR<17 | CRI 90+
Die casting aluminium



9 LED | 10W | 700lm
3000K | 4000K | 5000K | 6000K
UGR<17 | CRI 90+
Die casting aluminium



12 LED | 15W | 1050lm
3000K | 4000K | 5000K | 6000K
UGR<17 | CRI 90+
Die casting aluminium



16 LED | 15W | 1050lm
3000K | 4000K | 5000K | 6000K
UGR<17 | CRI 90+
Die casting aluminium



25 LED | 20W | 1400lm
3000K | 4000K | 5000K | 6000K
UGR<17 | CRI 90+
Die casting aluminium

光学角度/Beam



芯片/Chip



可选反射器颜色/Available Colors

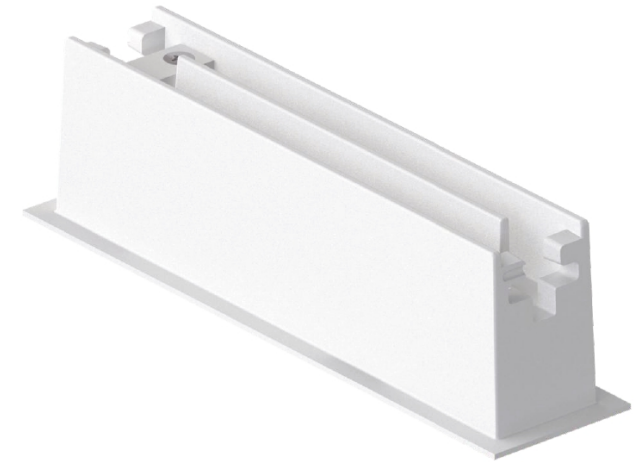

61x26
XTD6-A-3

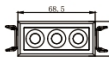

45x45
XTD6-A-4

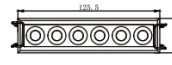

121x26
XTD6-A-6

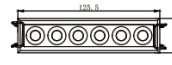

61x61
XTD6-A-9

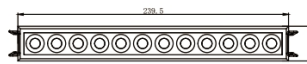

235x26
XTD6-A-12

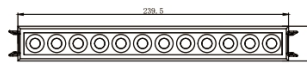

83x83
XTD6-A-16



101.5x101.5
XTD6-A-25



1 LED | 3W



2 LED | 5W



3 LED | 8W



4 LED



5 LED

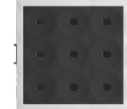

9 LED

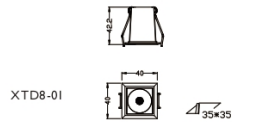

XTD8-01



XTD8-02

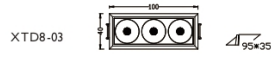

XTD8-03

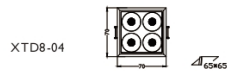

XTD8-04

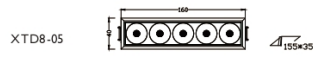

XTD8-05

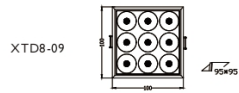

XTD8-09



4 LED | 5W



9 LED | 10W

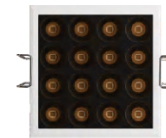

16 LED | 15W

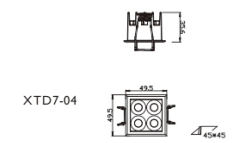

XTD7-04

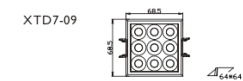

XTD7-09

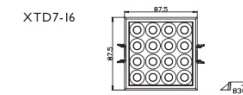

XTD7-16

光学角度/Beam



24°

芯片/Chip



SMD

光学角度/Beam



15° 24° 30°

芯片/Chip



SMD



TD067-4

功率 [Power] : 5W
 色温 [CCT] : 3000K | 4000K | 5000K | 6000K
 流明 [Lumen] : 300lm
 遮光角 [Shielding angle] : 31.8°
 眩光值 [UGR] : < 17
 显指 [CRI] : 90+
 材质 [Material] : Die casting aluminium
 颜色 [Color] : WH/BK

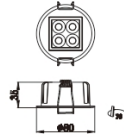

TD067-9

功率 [Power] : 10W
 色温 [CCT] : 3000K | 4000K | 5000K | 6000K
 流明 [Lumen] : 600lm
 遮光角 [Shielding angle] : 31.8°
 眩光值 [UGR] : < 17
 显指 [CRI] : 90+
 材质 [Material] : Die casting aluminium
 颜色 [Color] : WH/BK

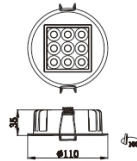

TD067-16

功率 [Power] : 16W
 色温 [CCT] : 3000K | 4000K | 5000K | 6000K
 流明 [Lumen] : 1040lm
 遮光角 [Shielding angle] : 31.8°
 眩光值 [UGR] : < 17
 显指 [CRI] : 90+
 材质 [Material] : Die casting aluminium
 颜色 [Color] : WH/BK

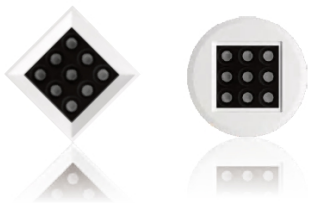
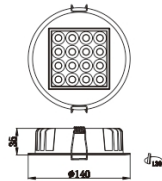

光学角度/Beam



芯片/Chip



可选反射器颜色/Available Colors

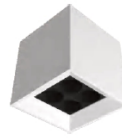

MD008-4

功率 [Power] : 5W
 色温 [CCT] : 3000K | 4000K | 5000K | 6000K
 流明 [Lumen] : 300lm
 眩光值 [UGR] : < 17
 显指 [CRI] : 90+
 材质 [Material] : Die casting aluminium
 颜色 [Color] : WH/BK

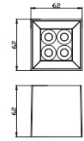

MD008-9

功率 [Power] : 10W
 色温 [CCT] : 3000K | 4000K | 5000K | 6000K
 流明 [Lumen] : 600lm
 眩光值 [UGR] : < 17
 显指 [CRI] : 90+
 材质 [Material] : Die casting aluminium
 颜色 [Color] : WH/BK

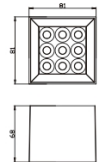

MD008-16

功率 [Power] : 16W
 色温 [CCT] : 3000K | 4000K | 5000K | 6000K
 流明 [Lumen] : 1040lm
 眩光值 [UGR] : < 17
 显指 [CRI] : 90+
 材质 [Material] : Die casting aluminium
 颜色 [Color] : WH/BK

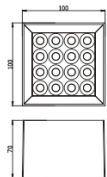

光学角度/Beam



芯片/Chip



可选反射器颜色/Available Colors





1 LED | 3W



3 LED | 6W



4 LED | 10W



5 LED | 12W



9 LED | 18W



10 LED | 24W

光学角度/Beam



芯片/Chip



1 LED | 3W



3 LED | 6W



4 LED | 10W



5 LED | 12W



9 LED | 18W



10 LED | 24W

光学角度/Beam



芯片/Chip



1 LED | 3W



3 LED | 6W



4 LED | 10W



5 LED | 12W



9 LED | 18W



10 LED | 24W

光学角度/Beam



芯片/Chip



1 LED | 3W



3 LED | 6W



4 LED | 10W



5 LED | 12W



9 LED | 18W



10 LED | 24W

光学角度/Beam



芯片/Chip



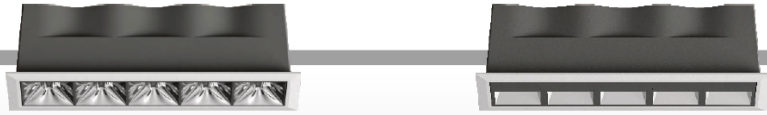

1 LED | 3W



3 LED | 6W



4 LED | 10W



5 LED | 12W



9 LED | 18W



10 LED | 24W



1 LED | 3W



3 LED | 6W



4 LED | 10W



5 LED | 12W



9 LED | 18W



10 LED | 24W

光学角度/Beam



Flood 40°

芯片/Chip



SMD

光学角度/Beam



Wallwasher

芯片/Chip



SMD



AW-XTD5-1



AW-XTD5-3



AW-XTD5-4



AW-XTD5-5



AW-XTD5-9



AW-XTD5-10



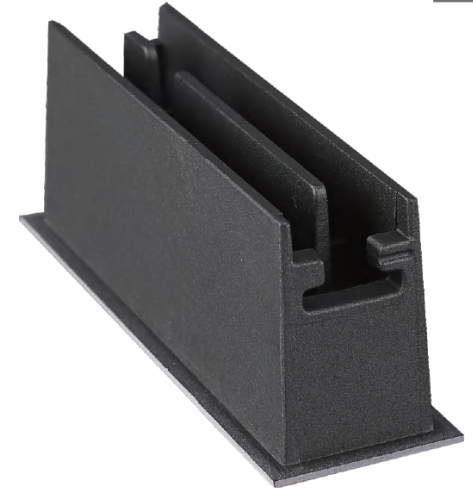
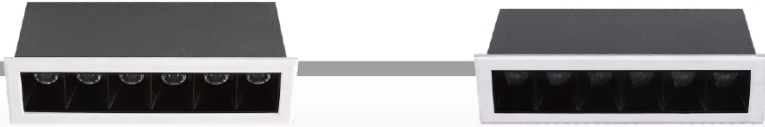

2 LED | 3W



2 LED | 3W



3 LED | 5W



3 LED | 5W



4 LED | 7W



4 LED | 7W



6 LED | 8W



6 LED | 8W



9 LED | 12W



9 LED | 12W



12 LED | 20W



12 LED | 20W

光学角度/Beam

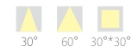

芯片/Chip



AW-XTD3-2

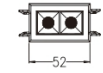

AW-XTD3-3

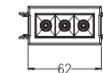

AW-XTD3-4

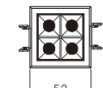

AW-XTD3-5

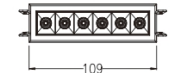

AW-XTD3-9

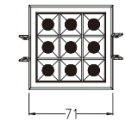
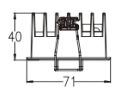

AW-XTD3-12

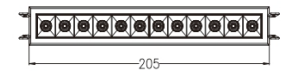



1 LED | 5W



3 LED | 12W



4 LED | 15W



5 LED | 20W



9 LED | 36W



10 LED | 40W



1 LED | 5W



3 LED | 12W



4 LED | 15W



5 LED | 20W



9 LED | 36W



10 LED | 40W

光学角度/Beam



芯片/Chip

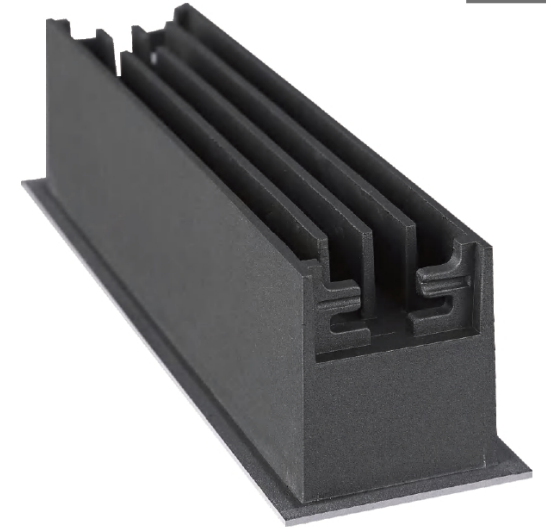

AW-XTD2-1

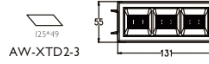

AW-XTD2-3

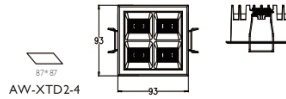

AW-XTD2-4



AW-XTD2-5

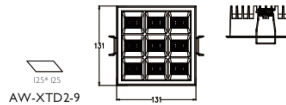

AW-XTD2-9



AW-XTD2-10



4 LED | 15W



4 LED | 15W



AW-MD006-4



9 LED | 36W



9 LED | 36W

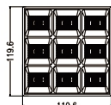

AW-MD006-9



6 LED | 15W

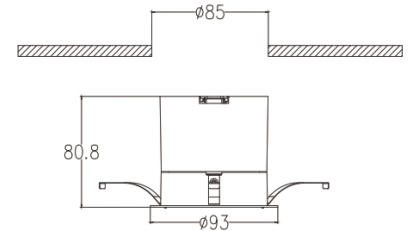

光学角度/Beam



芯片/Chip



光学角度/Beam



芯片/Chip





Trimless



1 LED | 3W



AW-XTD-A-01



45



1 LED | 3W



AW-XTD-B-01



41



2 LED | 5W



AW-XTD-A-02



75



2 LED | 5W



AW-XTD-B-02



71



5 LED | 12W



AW-XTD-A-05

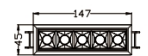

147



5 LED | 12W



AW-XTD-B-05



143



10 LED | 20W



AW-XTD-A-10

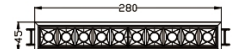

280



10 LED | 20W



AW-XTD-B-10



276



15 LED | 30W



AW-XTD-A-15



413



15 LED | 30W



AW-XTD-B-15



408

光学角度/Beam



芯片/Chip



LIGHT EFFECT

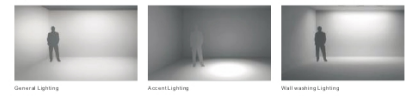

光学角度/Beam



芯片/Chip





5 LED | 10W

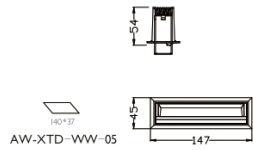

AW-XTD-WW-05



10 LED | 20W

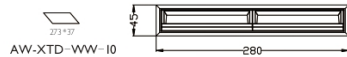

AW-XTD-WW-10



15 LED | 30W



AW-XTD-WW-15



10 LED | 10W

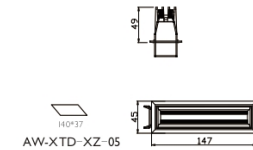

AW-XTD-XZ-05



20 LED | 20W

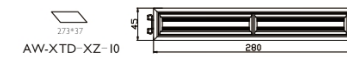

AW-XTD-XZ-10



30 LED | 30W



AW-XTD-XZ-15

光学角度/Beam



Wallwasher

芯片/Chip



SMD

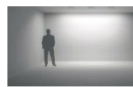

Wall-washing Lighting

光学角度/Beam



Flood 60°

芯片/Chip



SMD



10 LED | 20W

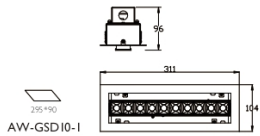

AW-GSD10-1



15 LED | 30W

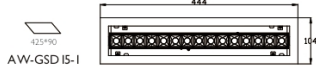

AW-GSD15-1



10 X 2 LED | 40W

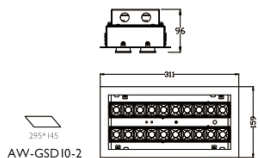

AW-GSD10-2

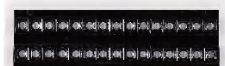

15 X 2 LED | 60W

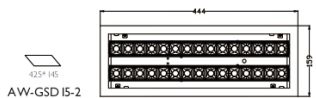

AW-GSD15-2



10 LED | 10W



AW-XTD3470-05



20 LED | 20W



AW-XTD3470-10



30 LED | 30W



AW-XTD3470-15



光学角度/Beam



芯片/Chip



光学角度/Beam



芯片/Chip



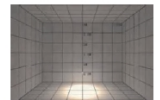
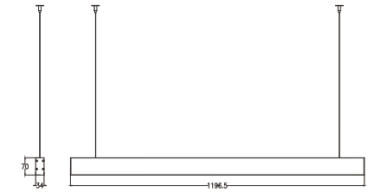
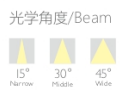
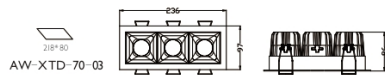
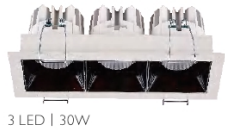
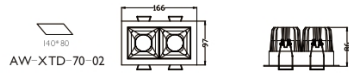
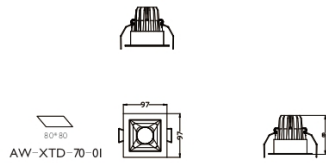

AW-XTD3470-1200A 30W

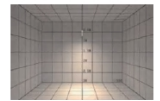

AW-XTD3470-1200B 40W

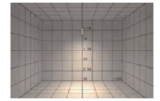

AW-XTD3470-1200C 40W

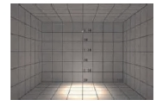

AW-XTD3470-1200D 40W



AW-XTD3470-1200E 40W



MINI SPOT

Light

迷你天花射灯系列



任意造形
随心所欲

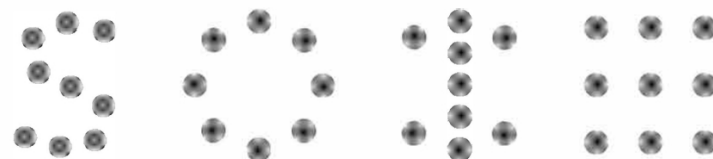



TSD009-25
 功率 [Power] : 2W
 角度 [Beam] : 15°, 27°, 60°
 芯片 [Chip] : OSRAM 3030
 材质 [Material] : Die-cast aluminum
 开孔 [Cutout] : Φ26mm



TSD009-35
 功率 [Power] : 3W
 角度 [Beam] : 15°, 25°, 50°
 芯片 [Chip] : OSRAM 3030
 材质 [Material] : Die-cast aluminum
 开孔 [Cutout] : Φ35mm



TSD009-50
 功率 [Power] : 5W
 角度 [Beam] : 15°, 25°, 45°
 芯片 [Chip] : OSRAM 3030
 材质 [Material] : Die-cast aluminum
 开孔 [Cutout] : Φ50mm



TSD009-60
 功率 [Power] : 8W
 角度 [Beam] : 20°, 40°
 芯片 [Chip] : COB CREE 1304
 材质 [Material] : Die-cast aluminum
 开孔 [Cutout] : Φ60mm

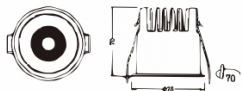

TSD009-70
 功率 [Power] : 12W
 角度 [Beam] : 15°, 24°, 36°
 芯片 [Chip] : COB CREE 1507
 材质 [Material] : Die-cast aluminum
 开孔 [Cutout] : Φ70mm

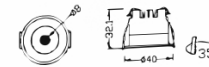

TSD010-35
 功率 [Power] : 3W
 材质 [Material] : Die-cast aluminum
 开孔 [Cutout] : Φ35mm

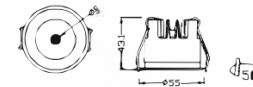

TSD010-50
 功率 [Power] : 4W
 材质 [Material] : Die-cast aluminum
 开孔 [Cutout] : Φ50mm

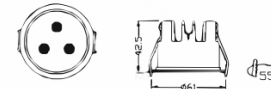

TSD010-55
 功率 [Power] : 8W
 材质 [Material] : Die-cast aluminum
 开孔 [Cutout] : Φ55mm

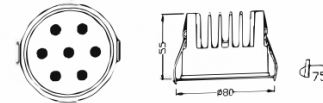

TSD010-75
 功率 [Power] : 15W
 材质 [Material] : Die-cast aluminum
 开孔 [Cutout] : Φ75mm

光学角度/Beam

 24°



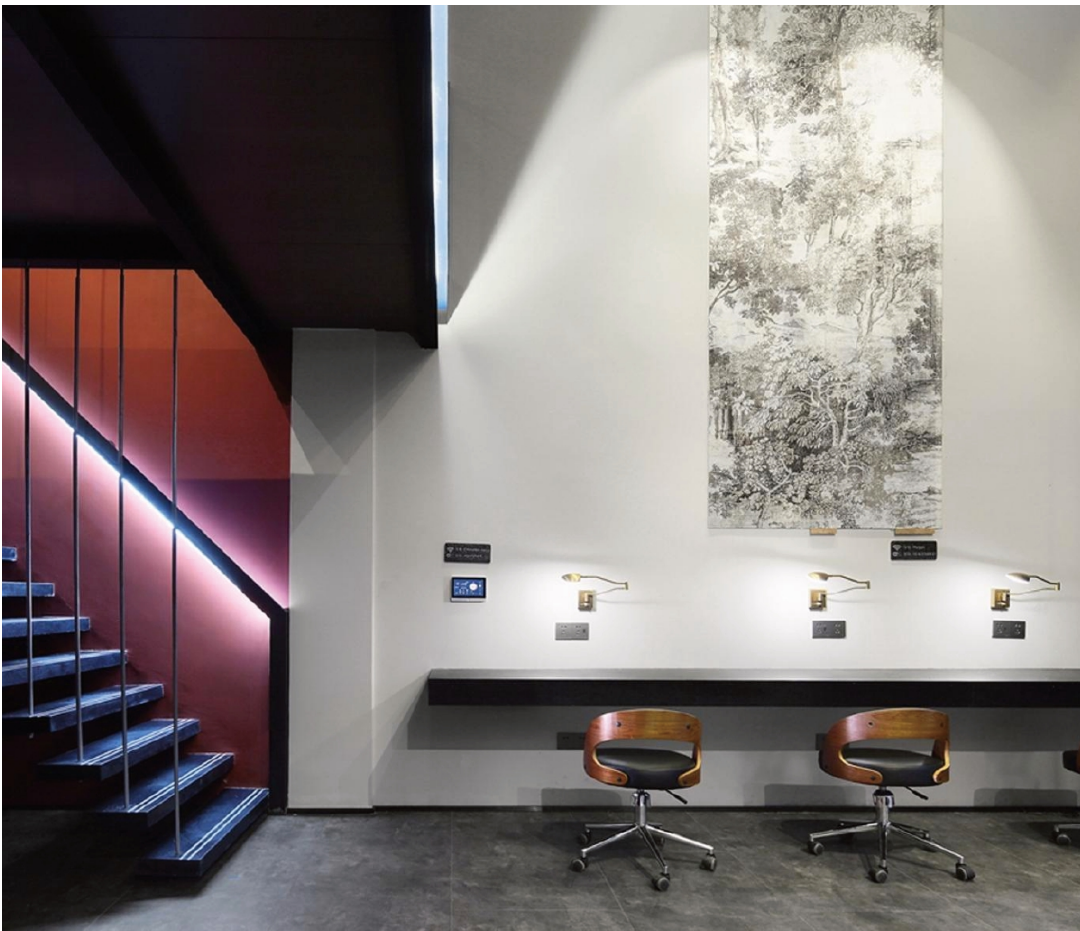

HTSD2-55

功率 [Power]: 5W
流明 [Lumen]: 450lm

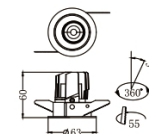

HTSD2-75

功率 [Power]: 9W
流明 [Lumen]: 810lm

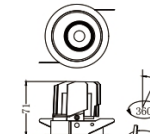

HTSD2-95

功率 [Power]: 15W
流明 [Lumen]: 1080lm

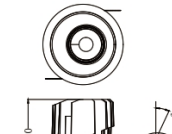

光学角度/Beam



芯片/Chip



COB

IP54

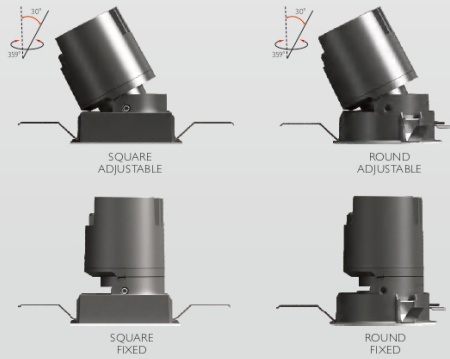

Rond



Square



Fixed/下照



Adjustable/可调



Wallwasher/洗墙



Fixed/下照



Adjustable/可调



Wallwasher/洗墙

Available Colors/可选反射器颜色



CH/铬色



GD/金色



SL/银色



BK/黑色



WH/白色



HTSD-F-S

HTSD-A-S



































HTSD-FW-S



HTSD-F-R

HTSD-A-R

HTSD-FW-R

可调(Adjustable) 					
					
HTSD-A-R60	HTSD-A-R80	HTSD-A-R100	HTSD-A-S60	HTSD-A-S80	HTSD-A-S100
					
					
					
7W	12W	20W	7W	12W	20W
 18° Narrow  24° Flood  36° Wide			 COB <small>无边 COB (无边 COB) 无边 COB (无边)</small>		
 CH/铬色  GD/金色  SL/银色  BK/黑色  WH/白色					
 Accessories/配件					



不可调(Fixed)					
HTSD-F-R60	HTSD-F-R80	HTSD-F-R100	HTSD-F-S60	HTSD-F-S80	HTSD-F-S100
7W	12W	20W	7W	12W	20W
<p>Accessories/配件</p>					



不可调(Fixed)					
HTSD-FW-R60	HTSD-FW-R80	HTSD-FW-R100	HTSD-FW-S60	HTSD-FW-S80	HTSD-FW-S100
7W	12W	20W	7W	12W	20W

型号命名方式/Product number structure

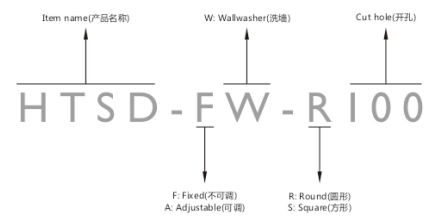



Ø50

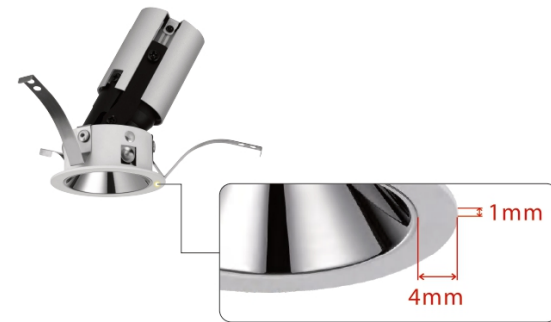

FOUNDATION

Fixed downlight

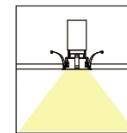

SD50A 5W



SD50A 8W



SD50A 12W

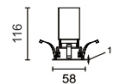
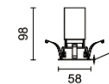
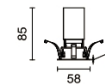

PICK UP

Adjustable downlight

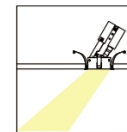

SD50B 5W



SD50B 8W

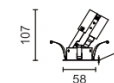
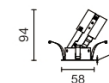

光学角度/Beam



24°
Narrow



36°
Wide

芯片/Chip



COB

ACCESSORIES



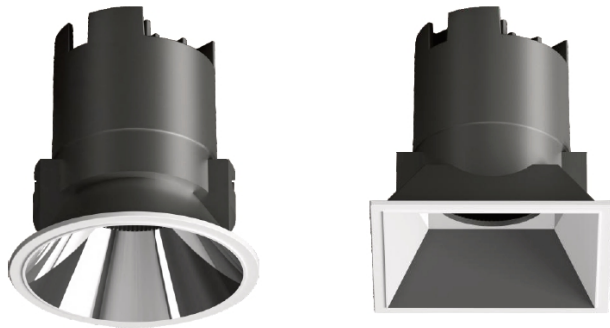

AW-TSD005

开孔 [Cutout] : $\Phi 75\text{mm}$
灯体 [Size] : $\Phi 82 \times H 85\text{mm}$



可选颜色/Optional Color



光学角度/Beam



芯片/Chip



AW-TSD006

开孔 [Cutout] : $75 \times 75\text{mm}$
灯体 [Size] : $82 \times 82 \times H 35.5\text{mm}$

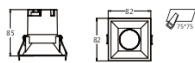

可选颜色/Optional Color

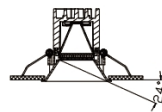

AW-TSD007

开孔 [Cutout] : $\Phi 75\text{mm}$
灯体 [Size] : $\Phi 82 \times H 35.5\text{mm}$



可选颜色/Optional Color



AW-TSD008

开孔 [Cutout] : $75 \times 75\text{mm}$
灯体 [Size] : $82 \times 82 \times H 35.5\text{mm}$



可选颜色/Optional Color



ACCESSORIES



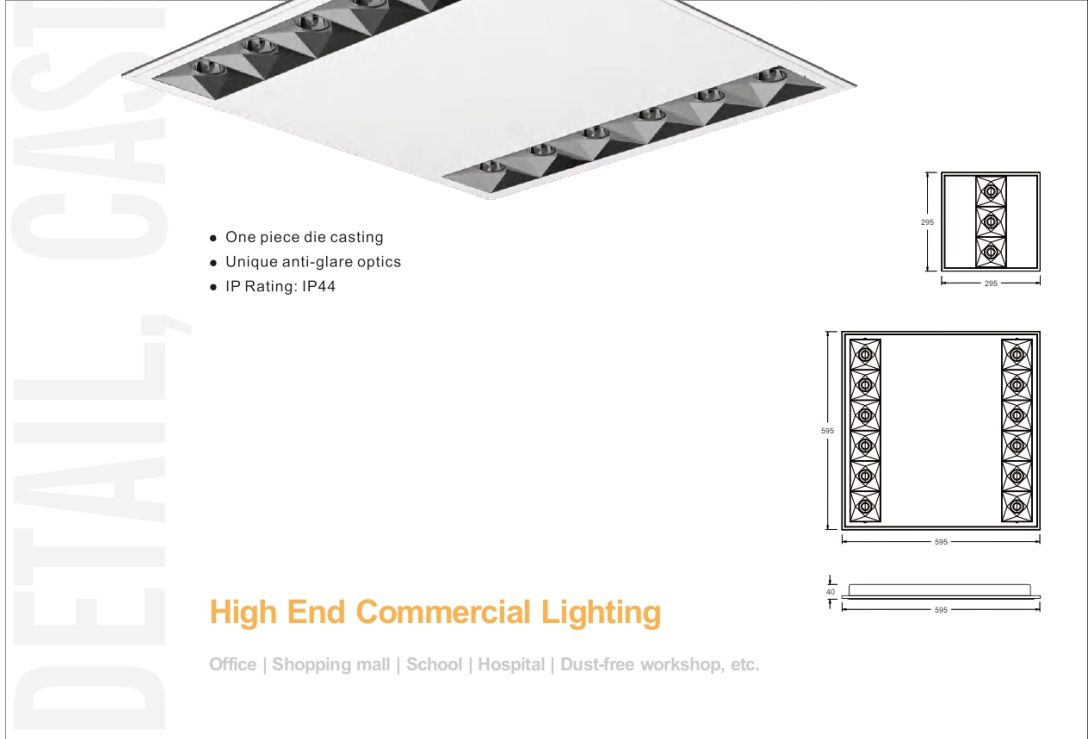
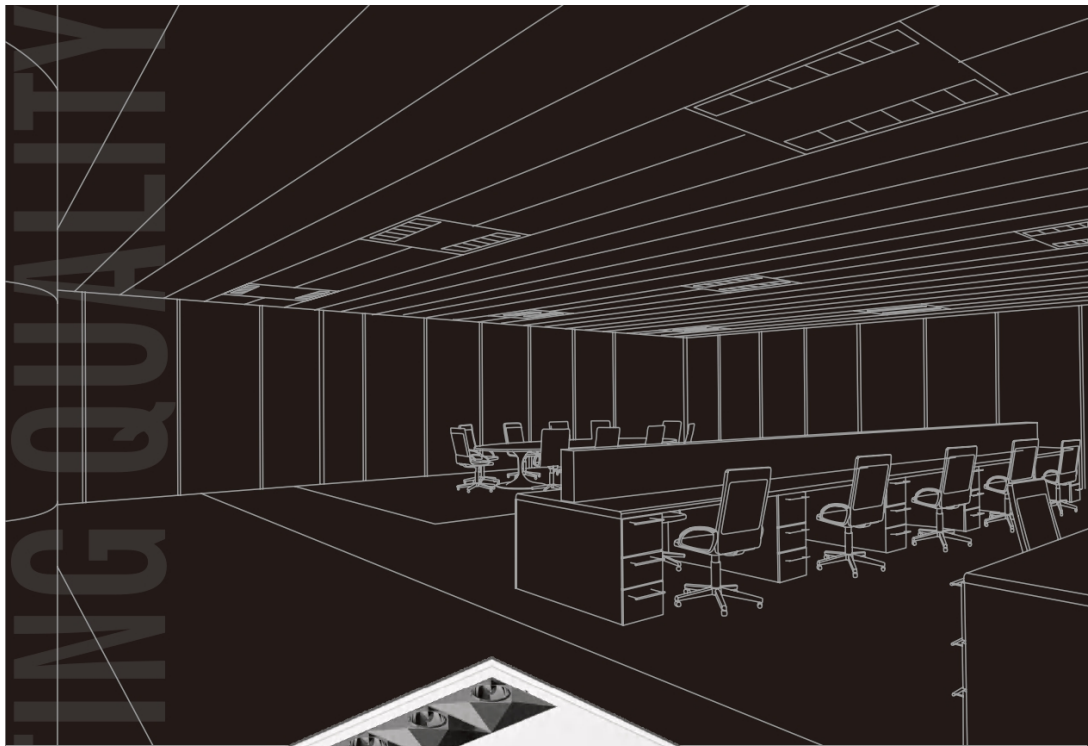

- One piece die casting
- Unique anti-glare optics
- IP Rating: IP44

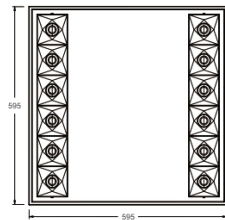
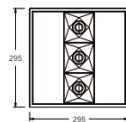

High End Commercial Lighting

Office | Shopping mall | School | Hospital | Dust-free workshop, etc.

MBD001



MBD001-AS300

功率 [Power]: 15W
 色温 [CCT]: 3000K | 4000K | 5000K | 6000K
 流明 [Lumen]: 1500lm
 眩光值 [UGR]: < 17
 显指 [CRI]: 80+
 IP等级 [IP Rating]: IP44
 材质 [Material]: Die casting aluminium
 颜色 [Color]: WH/BK
 安装 [Installation]: Suspension OR Recessed(☞A7 280×280mm)



MBD001-AS600

功率 [Power]: 40W
 色温 [CCT]: 3000K | 4000K | 5000K | 6000K
 流明 [Lumen]: 4000lm
 眩光值 [UGR]: < 17
 显指 [CRI]: 80+
 IP等级 [IP Rating]: IP44
 材质 [Material]: Die casting aluminium
 颜色 [Color]: WH/BK
 安装 [Installation]: Suspension OR Recessed(☞A7 580×580mm)

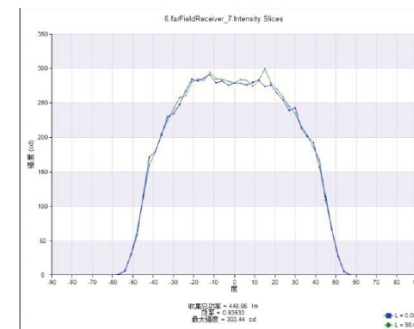

角度/Beam: 86°
 K: 632.1 cd/klm

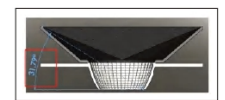

遮光角/Shielding angle: 31.8°

MBD003-AS300×300

功率 [Power]: 15W
 色温 [CCT]: 3000K | 4000K | 5000K | 6000K
 流明 [Lumen]: 1500lm
 眩光值 [UGR]: < 17
 显指 [CRI]: 80+
 材质 [Material]: Iron+PC
 颜色 [Color]: WH

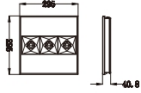

MBD003-AS300×600

功率 [Power]: 30W
 色温 [CCT]: 3000K | 4000K | 5000K | 6000K
 流明 [Lumen]: 3000lm
 眩光值 [UGR]: < 17
 显指 [CRI]: 80+
 材质 [Material]: Iron+PC
 颜色 [Color]: WH

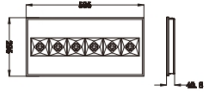

MBD003-AS300×1200

功率 [Power]: 40W
 色温 [CCT]: 3000K | 4000K | 5000K | 6000K
 流明 [Lumen]: 4000lm
 眩光值 [UGR]: < 17
 显指 [CRI]: 80+
 材质 [Material]: Iron+PC
 颜色 [Color]: WH

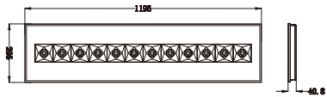

光学角度/Beam



86°

遮光角/Shielding angle: 31.8°



MBD003-AS600×600-2

功率 [Power]: 40W
 色温 [CCT]: 3000K | 4000K | 5000K | 6000K
 流明 [Lumen]: 4000lm
 眩光值 [UGR]: < 17
 显指 [CRI]: 80+
 材质 [Material]: Iron+PC
 颜色 [Color]: WH

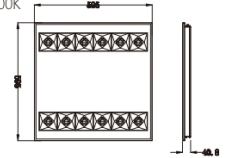

MBD003-AS600×1200-2

功率 [Power]: 80W
 色温 [CCT]: 3000K | 4000K | 5000K | 6000K
 流明 [Lumen]: 8000lm
 眩光值 [UGR]: < 17
 显指 [CRI]: 80+
 材质 [Material]: Iron+PC
 颜色 [Color]: WH

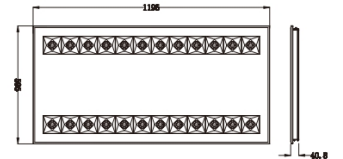

光学角度/Beam



86°

遮光角/Shielding angle: 31.8°



MBD003



MBD003-AS600×600-3

功率 [Power]: 60W
色温 [CCT]: 3000K | 4000K | 5000K | 6000K
流明 [Lumen]: 6000lm
眩光值 [UGR]: < 17
显指 [CRI]: 80+
材质 [Material]: Iron+PC
颜色 [Color]: WH

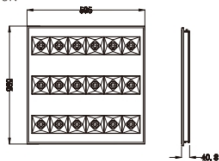

MBD003-AS600×1200-3

功率 [Power]: 120W
色温 [CCT]: 3000K | 4000K | 5000K | 6000K
流明 [Lumen]: 12000lm
眩光值 [UGR]: < 17
显指 [CRI]: 80+
材质 [Material]: Iron+PC
颜色 [Color]: WH

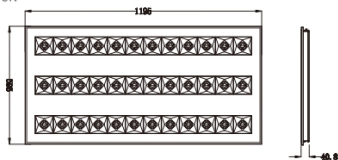

光学角度/Beam



86°

遮光角/Shielding angle: 31.8°





MBD002-AS300×300

功率 [Power]: 15W
 色温 [CCT]: 3000K | 4000K | 5000K | 6000K
 流明 [Lumen]: 1500lm
 眩光值 [UGR]: < 17
 显指 [CRI]: 80+
 材质 [Material]: Iron+PC
 颜色 [Color]: WH



MBD002-AS300×600

功率 [Power]: 30W
 色温 [CCT]: 3000K | 4000K | 5000K | 6000K
 流明 [Lumen]: 3000lm
 眩光值 [UGR]: < 17
 显指 [CRI]: 80+
 材质 [Material]: Iron+PC
 颜色 [Color]: WH

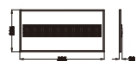

MBD002-AS300×1200

功率 [Power]: 40W
 色温 [CCT]: 3000K | 4000K | 5000K | 6000K
 流明 [Lumen]: 4000lm
 眩光值 [UGR]: < 17
 显指 [CRI]: 80+
 材质 [Material]: Iron+PC
 颜色 [Color]: WH



光学角度/Beam



81°

遮光角/Shielding angle: 31.8°



MBD002-AS600×600-I

功率 [Power]: 40W
 色温 [CCT]: 3000K | 4000K | 5000K | 6000K
 流明 [Lumen]: 4000lm
 眩光值 [UGR]: < 17
 显指 [CRI]: 80+
 材质 [Material]: Iron+PC
 颜色 [Color]: WH

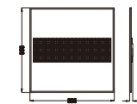

MBD002-AS600×1200-I

功率 [Power]: 80W
 色温 [CCT]: 3000K | 4000K | 5000K | 6000K
 流明 [Lumen]: 8000lm
 眩光值 [UGR]: < 17
 显指 [CRI]: 80+
 材质 [Material]: Iron+PC
 颜色 [Color]: WH

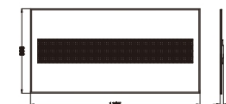

光学角度/Beam



81°

遮光角/Shielding angle: 31.8°





MBD002-AS600×600-2

功率 [Power]: 40W
 色温 [CCT]: 3000K | 4000K | 5000K | 6000K
 流明 [Lumen]: 4000lm
 眩光值 [UGR]: < 17
 显指 [CRI]: 80+
 材质 [Material]: Iron+PC
 颜色 [Color]: WH

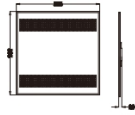

MBD002-AS600×1200-2

功率 [Power]: 80W
 色温 [CCT]: 3000K | 4000K | 5000K | 6000K
 流明 [Lumen]: 8000lm
 眩光值 [UGR]: < 17
 显指 [CRI]: 80+
 材质 [Material]: Iron+PC
 颜色 [Color]: WH

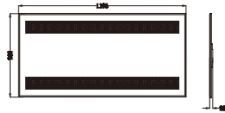

光学角度/Beam



81°

遮光角/Shielding angle: 31.8°



MBD002-AS600×600-3

功率 [Power]: 60W
 色温 [CCT]: 3000K | 4000K | 5000K | 6000K
 流明 [Lumen]: 6000lm
 眩光值 [UGR]: < 17
 显指 [CRI]: 80+
 材质 [Material]: Iron+PC
 颜色 [Color]: WH

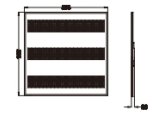

MBD002-AS600×1200-3

功率 [Power]: 120W
 色温 [CCT]: 3000K | 4000K | 5000K | 6000K
 流明 [Lumen]: 12000lm
 眩光值 [UGR]: < 17
 显指 [CRI]: 80+
 材质 [Material]: Iron+PC
 颜色 [Color]: WH

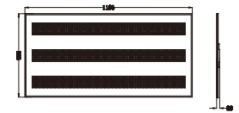

光学角度/Beam



81°

遮光角/Shielding angle: 31.8°





AW-TD065-2F

功率 [Power] : 5W
 开孔 [Cutout] : $\Phi 75$ mm
 灯体 [Size] : $\Phi 80 \times H 40$ mm



AW-TD065-3F

功率 [Power] : 7W
 开孔 [Cutout] : $\Phi 85$ mm
 灯体 [Size] : $\Phi 96 \times H 47$ mm

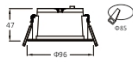

AW-TD065-3_5F

功率 [Power] : 9W
 开孔 [Cutout] : $\Phi 100$ mm
 灯体 [Size] : $\Phi 113 \times H 55$ mm

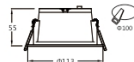

AW-TD065-4F

功率 [Power] : 12W
 开孔 [Cutout] : $\Phi 120$ mm
 灯体 [Size] : $\Phi 138 \times H 64$ mm

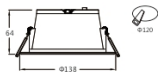

AW-TD065-5F

功率 [Power] : 15W
 开孔 [Cutout] : $\Phi 140$ mm
 灯体 [Size] : $\Phi 165 \times H 74$ mm

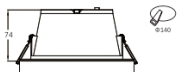

AW-TD065-6F

功率 [Power] : 20W
 开孔 [Cutout] : $\Phi 170$ mm
 灯体 [Size] : $\Phi 195 \times H 85$ mm

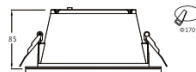

AW-TD065-8F

功率 [Power] : 30W
 开孔 [Cutout] : $\Phi 200$ mm
 灯体 [Size] : $\Phi 228 \times H 97$ mm

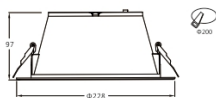

可选颜色/Optional Color



银色/SL 铬色/CH 白色/WH

光学角度/Beam



60° Flood

芯片/Chip



COB



SMD



SPOT

Light

天花射灯系列



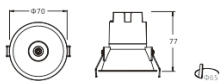

TSD002-2F
 功率 [Power] : 5W
 材质 [Material] : Die-cast aluminum+PC
 开孔 [Cutout] : Φ65mm

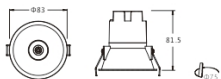

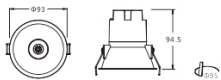

TSD002-2.5F
 功率 [Power] : 5W
 材质 [Material] : Die-cast aluminum+PC
 开孔 [Cutout] : Φ75mm

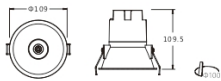

TSD002-3F
 功率 [Power] : 10W
 材质 [Material] : Die-cast aluminum+PC
 开孔 [Cutout] : Φ85mm



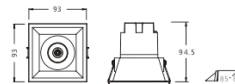
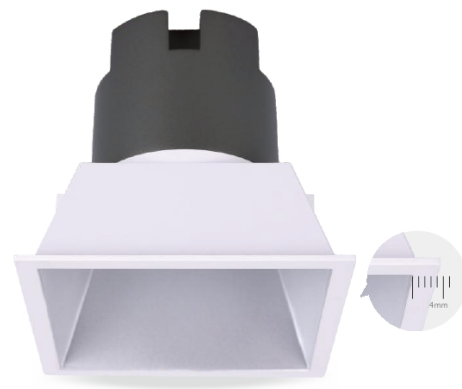
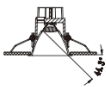

TSD002-3.5F
 功率 [Power] : 10W
 材质 [Material] : Die-cast aluminum+PC
 开孔 [Cutout] : Φ100mm

光学角度/Beam | 芯片/Chip



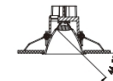

TSD003-3F
 功率 [Power] : 10W
 材质 [Material] : Die-cast aluminum+PC
 开孔 [Cutout] : 85*85mm

光学角度/Beam | 芯片/Chip

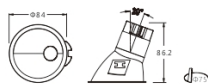







TSD002X-2F
 功率 [Power] : 5W
 材质 [Material] : Die-cast aluminum+PC
 开孔 [Cutout] : Φ 75mm

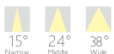

TSD002X-3F
 功率 [Power] : 5W
 材质 [Material] : Die-cast aluminum+PC
 开孔 [Cutout] : Φ 85mm

光学角度/Beam | 芯片/Chip





TSD003X-3F
 功率 [Power] : 5W
 材质 [Material] : Die-cast aluminum+PC
 开孔 [Cutout] : 85*85mm

光学角度/Beam | 芯片/Chip





IP54



AW-TD059-3F

功率 [Power]: 10W
 开孔 [Cutout]: $\Phi 90$ mm
 灯体 [Size]: $\Phi 100 \times H 75$ mm



AW-TD059-4F

功率 [Power]: 20W
 开孔 [Cutout]: $\Phi 130$ mm
 灯体 [Size]: $\Phi 140 \times H 90$ mm



AW-TD059-6F

功率 [Power]: 30W
 开孔 [Cutout]: $\Phi 170$ mm
 灯体 [Size]: $\Phi 185 \times H 112$ mm



AW-TD059-8F

功率 [Power]: 40W
 开孔 [Cutout]: $\Phi 200$ mm
 灯体 [Size]: $\Phi 230 \times H 128$ mm

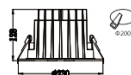

参数/Parameter

色温 [Color temp.]: 2700K | 3000K | 4000K | 5000K
 材质 [Material]: Die-Cast Aluminum+PC
 环境温度 [Temp.]: $-20^{\circ}\text{C} \sim +50^{\circ}\text{C}$
 灯体颜色 [Body color]: WH

光学角度/Beam



芯片/Chip



反光杯颜色/Reflector



IP54



AW-MD005-3F

功率 [Power]: 10W
 灯体 [Size]: $\Phi 82 \times H 106$ mm



AW-MD005-4F

功率 [Power]: 20W
 灯体 [Size]: $\Phi 115 \times H 120$ mm



AW-MD005-6F

功率 [Power]: 30W
 灯体 [Size]: $\Phi 149 \times H 143$ mm



AW-MD005-8F

功率 [Power]: 40W
 灯体 [Size]: $\Phi 187.5 \times H 159$ mm



参数/Parameter

色温 [Color temp.]: 2700K | 3000K | 4000K | 5000K
 材质 [Material]: Die-Cast Aluminum+PC
 环境温度 [Temp.]: $-20^{\circ}\text{C} \sim +50^{\circ}\text{C}$
 灯体颜色 [Body color]: WH | BK

光学角度/Beam



芯片/Chip



反光杯颜色/Reflector





AW-TD062-2.5F

功率 [Power]: 7W
 开孔 [Cutout]: $\Phi 75$ mm
 灯体 [Size]: $\Phi 88 \times H 77$ mm



AW-TD062-3.5F

功率 [Power]: 12W
 开孔 [Cutout]: $\Phi 90$ mm
 灯体 [Size]: $\Phi 105 \times H 87$ mm

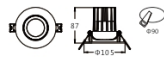

AW-TD062-4F

功率 [Power]: 20W
 开孔 [Cutout]: $\Phi 120$ mm
 灯体 [Size]: $\Phi 135 \times H 108$ mm

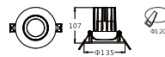

参数/Parameter

色温 [Color temp.]: 2700K | 3000K | 4000K | 5000K
 材质 [Material]: Die-Cast Aluminum
 环境温度 [Temp.]: $-20^{\circ}\text{C} \sim +50^{\circ}\text{C}$
 灯体颜色 [Body color]: WH+BK

光学角度/Beam



芯片/Chip



AW-TD063-2.5F

功率 [Power]: 7W
 开孔 [Cutout]: $\Phi 75$ mm
 灯体 [Size]: $88 \times 88 \times H 77$ mm



AW-TD063-3.5F

功率 [Power]: 12W
 开孔 [Cutout]: $\Phi 90$ mm
 灯体 [Size]: $105 \times 105 \times H 87$ mm



AW-TD063-4F

功率 [Power]: 20W
 开孔 [Cutout]: $\Phi 120$ mm
 灯体 [Size]: $135 \times 135 \times H 108$ mm



参数/Parameter

色温 [Color temp.]: 2700K | 3000K | 4000K | 5000K
 材质 [Material]: Die-Cast Aluminum
 环境温度 [Temp.]: $-20^{\circ}\text{C} \sim +50^{\circ}\text{C}$
 灯体颜色 [Body color]: WH+BK

光学角度/Beam



芯片/Chip





A款/Trim



B款/Trim

AW-TD052-2.5F

功率 [Power] : 5W
开孔 [Cutout] : Φ75mm
灯体 [Size] : Φ90×H56mm

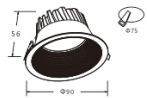

AW-TD052-3F

功率 [Power] : 9W
开孔 [Cutout] : Φ90mm
灯体 [Size] : Φ110×H68mm

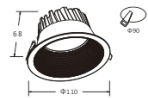

AW-TD052-4F

功率 [Power] : 15W
开孔 [Cutout] : Φ120mm
灯体 [Size] : Φ137.5×H82mm

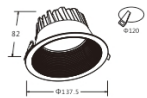

AW-TD052-5F

功率 [Power] : 20W
开孔 [Cutout] : Φ140mm
灯体 [Size] : Φ165×H91mm

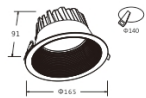

AW-TD052-6F

功率 [Power] : 30W
开孔 [Cutout] : Φ170mm
灯体 [Size] : Φ195×H107mm

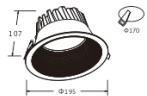

AW-TD052-8F

功率 [Power] : 40W
开孔 [Cutout] : Φ200mm
灯体 [Size] : Φ235×H127.5mm



参数/Parameter

色温 [Color temp.] : 2700K | 3000K | 4000K | 5000K
材质 [Material] : Die-Cast Aluminum
环境温度 [Temp.] : -20°C ~ +50°C
灯体颜色 [Body color] : WH

芯片/Chip



SMD



A款/Trim



B款/Trim

AW-TD05I-2.5F

功率 [Power] : 5W
开孔 [Cutout] : Φ75mm
灯体 [Size] : Φ90×H56mm

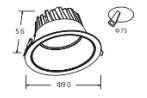

AW-TD05I-3F

功率 [Power] : 9W
开孔 [Cutout] : Φ90mm
灯体 [Size] : Φ110×H68mm

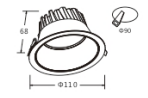

AW-TD05I-4F

功率 [Power] : 15W
开孔 [Cutout] : Φ120mm
灯体 [Size] : Φ137.5×H82mm

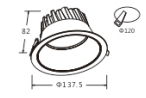

AW-TD05I-5F

功率 [Power] : 20W
开孔 [Cutout] : Φ140mm
灯体 [Size] : Φ165×H91mm

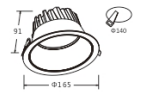

AW-TD05I-6F

功率 [Power] : 30W
开孔 [Cutout] : Φ170mm
灯体 [Size] : Φ195×H107mm

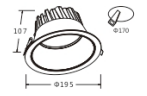

AW-TD05I-8F

功率 [Power] : 40W
开孔 [Cutout] : Φ200mm
灯体 [Size] : Φ235×H127.5mm

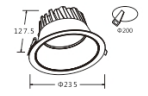

参数/Parameter

色温 [Color temp.] : 2700K | 3000K | 4000K | 5000K
材质 [Material] : Die-Cast Aluminum
环境温度 [Temp.] : -20°C ~ +50°C
灯体颜色 [Body color] : WH

光学角度/Beam



50°
Wide

芯片/Chip



COB

高显指 (Ra>90)



AW-TD055-2.5F

功率 [Power]: 3W
 开孔 [Cutout]: $\Phi 70$ mm
 灯体 [Size]: A/ $\Phi 98 \times H 31$ mm
 B/C/ $\Phi 98 \times H 36$ mm



AW-TD055-3F

功率 [Power]: 5W
 开孔 [Cutout]: $\Phi 80$ mm
 灯体 [Size]: A/ $\Phi 108 \times H 31$ mm
 B/C/ $\Phi 108 \times H 36$ mm



AW-TD055-3.5F

功率 [Power]: 7W
 开孔 [Cutout]: $\Phi 90$ mm
 灯体 [Size]: A/ $\Phi 118 \times H 31.5$ mm
 B/C/ $\Phi 118 \times H 36$ mm



AW-TD055-4F

功率 [Power]: 9W
 开孔 [Cutout]: $\Phi 115$ mm
 灯体 [Size]: A/ $\Phi 138 \times H 32$ mm
 B/C/ $\Phi 138 \times H 38.5$ mm



AW-TD055-5F

功率 [Power]: 12W
 开孔 [Cutout]: $\Phi 155$ mm
 灯体 [Size]: A/ $\Phi 178 \times H 36$ mm
 B/C/ $\Phi 180 \times H 43.5$ mm



AW-TD055-6F

功率 [Power]: 20W
 开孔 [Cutout]: $\Phi 160$ mm
 灯体 [Size]: A/ $\Phi 188 \times H 36$ mm
 B/C/ $\Phi 190 \times H 45$ mm



AW-TD055-8F

功率 [Power]: 30W
 开孔 [Cutout]: $\Phi 210$ mm
 灯体 [Size]: A/ $\Phi 240 \times H 40$ mm
 B/C/ $\Phi 240 \times H 56$ mm



参数/Parameter

色温 [Color temp.]: 2700K | 3000K | 4000K | 5000K
 材质 [Material]: Aluminum+Die-Cast Aluminum
 环境温度 [Temp.]: -20°C~+50°C
 灯体颜色 [Body color]: WH+GREY

芯片/Chip



AW-TD056-2.5F

功率 [Power]: 5W
 开孔 [Cutout]: $\Phi 70$ mm
 灯体 [Size]: A/ $\Phi 98 \times H 40$ mm
 B/C/ $\Phi 98 \times H 51$ mm



AW-TD056-3F

功率 [Power]: 7W
 开孔 [Cutout]: $\Phi 80$ mm
 灯体 [Size]: A/ $\Phi 108 \times H 41$ mm
 B/C/ $\Phi 108 \times H 54$ mm



AW-TD056-3.5F

功率 [Power]: 9W
 开孔 [Cutout]: $\Phi 90$ mm
 灯体 [Size]: A/ $\Phi 118 \times H 41$ mm
 B/C/ $\Phi 118 \times H 54$ mm



AW-TD056-4F

功率 [Power]: 12W
 开孔 [Cutout]: $\Phi 115$ mm
 灯体 [Size]: A/ $\Phi 138 \times H 53$ mm
 B/C/ $\Phi 138 \times H 60$ mm



AW-TD056-5F

功率 [Power]: 15W
 开孔 [Cutout]: $\Phi 155$ mm
 灯体 [Size]: A/ $\Phi 178 \times H 63$ mm
 B/C/ $\Phi 180 \times H 70$ mm



AW-TD056-6F

功率 [Power]: 20W
 开孔 [Cutout]: $\Phi 160$ mm
 灯体 [Size]: A/ $\Phi 188 \times H 68$ mm
 B/C/ $\Phi 190 \times H 78$ mm



AW-TD056-8F

功率 [Power]: 30W
 开孔 [Cutout]: $\Phi 210$ mm
 灯体 [Size]: A/ $\Phi 240 \times H 75$ mm
 B/C/ $\Phi 240 \times H 93$ mm



参数/Parameter

色温 [Color temp.]: 2700K | 3000K | 4000K | 5000K
 材质 [Material]: Aluminum+Die-Cast Aluminum
 环境温度 [Temp.]: -20°C~+50°C
 灯体颜色 [Body color]: WH+GREY

光学角度/Beam



芯片/Chip



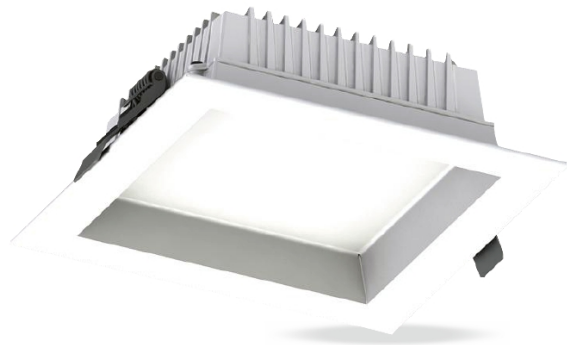

AW-TD058-4F

功率 [Power] : 12W
 开孔 [Cutout] : L105×W105mm
 灯体 [Size] : L120×W120×H51mm

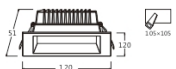

AW-TD058-6F

功率 [Power] : 20W
 开孔 [Cutout] : L145×W145mm
 灯体 [Size] : L167×W167×H54mm



AW-TD058-8F

功率 [Power] : 25W
 开孔 [Cutout] : L185×W185mm
 灯体 [Size] : L215×W215×H55mm

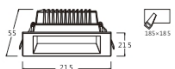

参数/Parameter

色温 [Color temp.] : 2700K | 3000K | 4000K | 5000K
 材质 [Material] : Die-Cast Aluminum
 环境温度 [Temp.] : -20°C ~ +50°C
 灯体颜色 [Body color] : WH

芯片/Chip



TD053A



TD053B



AW-TD053-3F

功率 [Power] : 10W
 开孔 [Cutout] : Φ95mm
 灯体 [Size] : Φ110×H61mm

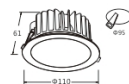

AW-TD053-4F

功率 [Power] : 15W
 开孔 [Cutout] : Φ110mm
 灯体 [Size] : Φ135×H69mm

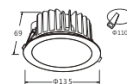

AW-TD053-5F

功率 [Power] : 25W
 开孔 [Cutout] : Φ130mm
 灯体 [Size] : Φ160×H75mm

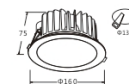

AW-TD053-6F

功率 [Power] : 40W
 开孔 [Cutout] : Φ165mm
 灯体 [Size] : Φ185×H100mm



AW-TD053-8F

功率 [Power] : 60W
 开孔 [Cutout] : Φ205mm
 灯体 [Size] : Φ240×H120mm

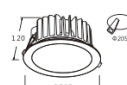

参数/Parameter

色温 [Color temp.] : 2700K | 3000K | 4000K | 5000K
 材质 [Material] : Die-Cast Aluminum
 环境温度 [Temp.] : -20°C ~ +50°C
 灯体颜色 [Body color] : WH

光学角度/Beam



芯片/Chip





AW-SD002-4F

功率 [Power]: 15W
 开孔 [Cutout]: $\Phi 120$ mm
 灯体 [Size]: $\Phi 130 \times H110$ mm



AW-SD002-5F

功率 [Power]: 30W
 开孔 [Cutout]: $\Phi 155$ mm
 灯体 [Size]: $\Phi 165 \times H143$ mm



AW-SD002-6F

功率 [Power]: 40W
 开孔 [Cutout]: $\Phi 170$ mm
 灯体 [Size]: $\Phi 190 \times H155$ mm



参数/Parameter

色温 [Color temp.]: 2700K | 3000K | 4000K | 5000K
 材质 [Material]: Die-Cast Aluminum+PC
 环境温度 [Temp.]: $-20^{\circ}\text{C} \sim +50^{\circ}\text{C}$
 灯体颜色 [Body color]: WH

光学角度/Beam



24°
Flood

芯片/Chip



COB

TRACK

Light

轨道灯系列



GD003-D60

功率 [Power]: 10W
 灯体 [Size]: $\Phi 60 \times H100$ mm



GD003-D80

功率 [Power]: 20W
 灯体 [Size]: $\Phi 80 \times H120$ mm



GD003-D90

功率 [Power]: 30W
 灯体 [Size]: $\Phi 90 \times H140$ mm



参数/Parameter

色温 [Color temp.]: 2700K | 3000K | 4000K | 5000K
 材质 [Material]: Aluminum+PC
 环境温度 [Temp.]: $-20^{\circ}\text{C} \sim +50^{\circ}\text{C}$
 灯体颜色 [Body color]: WH | BK

光学角度/Beam



15° Narrow | 24° Flood | 38° Wide

芯片/Chip



COB